

OWNER' S MANUAL

WIRE CONTROLLER OF AIR CONDITIONER

MODEL: KJR-12B/DPBG(T)-E

Brivis Part No:B026000

Brivis Climate Systems Pty Ltd

Tel:1300 BRIVIS

brivis.com.au

Thank you very much for purchasing our product.
Before using your unit, please read this manual carefully and keep it for future reference.

- This manual gives detailed description of the precautions that should be brought to your attention during operation.
- In order to ensure correct service of the wired controller please read this manual carefully before using the unit.
- For convenience of future reference, keep this manual after reading it.



CONTENTS

1. SAFETY PRECAUTION.....	1
2. SUMMARIZE.....	2
3. FUNCTION SUMMARY.....	2
4. NAME AND FUNCTION OF INDICATORS ON THE WIRE CONTROLLER.....	3
5. INSTALLATION METHOD.....	4
6. NAME AND OPERATION OF THE BUTTON ON THE WIRE CONTROL- LER.....	5
7. USING METHOD	7
AUTOMATIC OPERATION.....	7
COOLING/HEATING/FAN ONLY OPERATION.....	7
DRY OPERATION.....	8
TIMER SETTING.....	8
TIMER ON AND TIMER OFF BOTH.....	8
CHANGE TIMER.....	9
8.TECHNICAL INDICATION AND REQUIREMENT	9

1. SAFETY PRECAUTIONS



The following contents are stated on the product and the operation manual, including usage, precautions against personal harm and property loss, and the methods of using the product correctly and safely. After fully understanding the following contents (identifiers and icons), read the text body and observe the following rules.

■ Identifier description

Identifier	Meaning
 Warning	Means improper handling may lead to personal death or severe injury.
 Caution	Means improper handling may lead to personal injury or property loss.

[Note]: 1. "Harm" means injury, burn and electric shock which need long-term treatment but need no hospitalization
2. "Property loss" means loss of properties and materials.

■ Icon description

Icon	Meaning
	It indicates forbidding. The forbidden subject-matter is indicated in the icon or by images or characters aside.
	It indicates compulsory implementation. The compulsory subject-matter is indicated in the icon or by images or characters aside.

Warning

 Warning	Delegate installation	Please entrust the distributor or professionals to install the unit. The installers must have the relevant know-how. Improper installation performed by the user without permission may cause fire, electric shock, personal injury or water leakage.
--	-----------------------	---

 Usage Warning	Forbid	Do not spray flammable aerosol to the wire controller directly. Otherwise, fire may occur.
	Forbid	Do not operate with wet hands or let water enter the wire controller. Otherwise, electric shock may occur.

2. SUMMARIZE

Usage condition:

1. Power supply: 5V DC.
2. Operation temperature: -15?--+43?.
3. Operation humidity: 40%-90%, RH.
4. Safely comply to:
GB4706.32-2004,GBT7725-2004.

3. FUNCTION SUMMARY

Main function:

1. Connecting to indoor unit by A, B, C, D, E terminals.
2. Button setting action mode.
3. LCD display.
4. Timer for rest time.

4. NAME AND FUCTION OF INDICATORS ON THE CONTROLLER

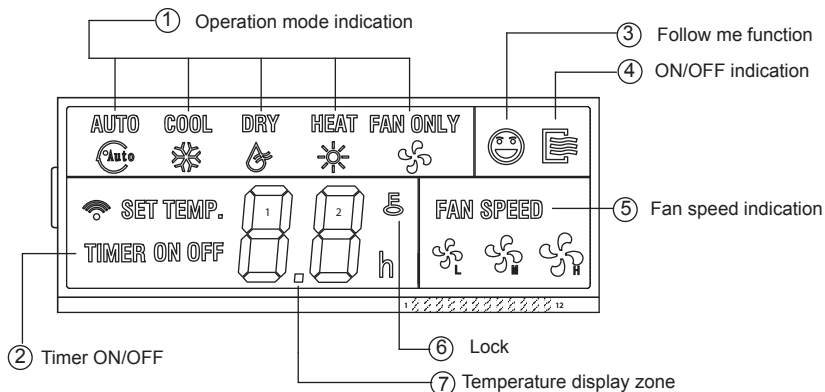

① Operation mode indication:

When press " MODE " button, the following mode can be selected in circle. Auto →Cool →Dry→Heat→Fan only→Auto. For cooling only model,heat mode is skipped.

② Timer :

When adjust setting on time or only on time is set, the "ON" is lighted.

When adjust setting off time or only off time is set , the "OFF" is lighted. If on and off timer are both set, the"ON" and "OFF"are both lighted.

③ Follow me function:

There is a temperature sensor inside the wire controller, after setting temperature, it will compare the two temperatures, and the space of wire controller will be

the same as setting temperature. It is available under cooling, heating, auto mode.

④ ON/OFF indication :

When it is on, the icon display, otherwise it is extinguished.

⑤ Fan speed indication :

There are four fan modes : low, middle, high, auto. For some models, no middle fan then the middle fan is seen as high

speed.

⑥ Lock:

When the " LOCK " button is pressed, the icon appear and other buttons is unable, press again, the icon disappear.

⑦ Temperature display zone:

Generally it displays setting temperature, it can be adjusted by press temperature button ▲ and ▼. But in fan mode, no display here.

5. INSTALLATION METHOD

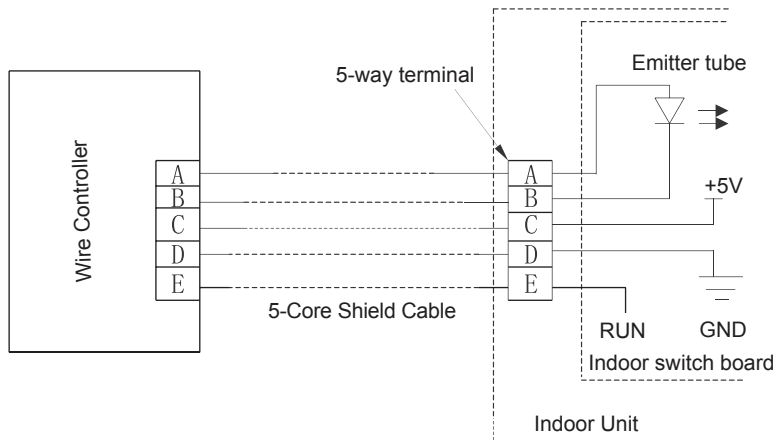

When a wire controller is needed, a small 5-way terminal should be added, fix an infrared emitter with gumwater near the receiver on the switch board. Connect its anode and cathode to A and B, and +5V, GND, RUN to C, D, E on the switch board.

6. NAME AND OPERATION OF THE BUTTON ON THE WIRE CONTROLLER

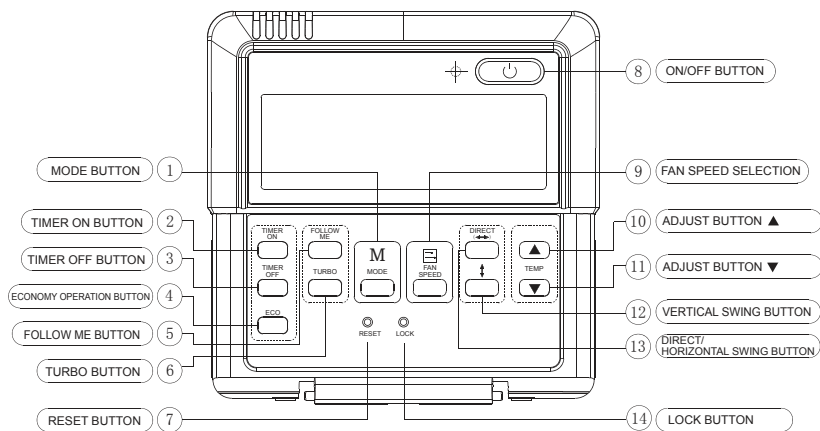

① Mode button:

When press this button, the operation mode change as the following sequence:

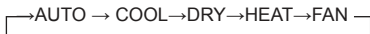

Remark: For the cooling only model, the heating mode is skipped.

② Timer on button :

Press this button, timer on function is active. Then every press, the time increase 0.5h, after 10h, 1h increase-ment after each press. If cancel this Function, just set it to "0.0" .

③ Timer off button:

Press this button, timer off function is active. Then every press, the time increase 0.5h, after 10h, 1h increase-ment after each press. If cancel this function, just set it to "0.0" .

④ Economy operation button:

press this button, the indoor unit operates in economy mode, press again, exit this mode (it may be ineffective for some models)

⑤ Follow me button:

When under cool, heat and auto mode, press this button, follow me function is active. Press again, this function is ineffective.

⑥ Turbo button :

If press this button in cooling mode, the fan speed will increase (available to some model with powerful function). If press this button in heatmode, electrical heater function become ineffective.

⑦ Reset button (hidden):

Use a 1mm stick to press in the little hole , then the current setting is canceled . The wire controller enter into original state.

⑧ ON/OFF button:

When in off state, press this button, the indicator is on, the wire controller enter into on state, and send setting information to in door Pcb. When in on state, press this button, the indicator is off, and send instruction. If timer on or timer off has been set, it cancel this setting then send instruction to stop the machine.

⑨ Fan speed button:

press this button consecutively, the fan speed will circle as follow:

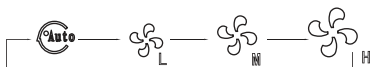

⑩ Adjust button ▲ :

Set indoor temperature up. If press and hold on, it will increase at 1 degree per 0.5 second.

⑪ Adjust button ▼ :

Set indoor temperature down . if press and hold on, it will decrease at 1degree per 0.5 second.

⑫ Vertical swing button:

First press, start swing function; second press, stop swing. (Match to some model with swing function).

⑬ Direct/horizontal swing button:

Press the button every time, the louver swings 6 degrees. Press and hold for over 2 seconds, it turns into horizontal swing mode, press it again to quit .

⑭ Lock button(hidden):

When you push the LOCK button, all current settings are locked in and the wire controller does not accept any operation except that of the LOCK button. Use the lock mode when you

want to prevent setting from being changed accidentally or play fully. Push the LOCK button again when you want to cancel the LOCK mode.

7. USING METHOD

AUTOMATIC OPERATION

Connect to power, indoor operation lamp flash.

1. Press "MODE" button, select " AUTO " ;
2. Press the button "▲" and "▼", set temperature you want, generally it is among 17℃~30℃;
3. Press " ON/OFF" button, operation lamp is on, the air-conditioner work in auto mode, indoor fan is auto, and can not be changed. Auto is displayed on LCD. Press ON/OFF button again to stop.
4. Economy operation is valid in auto mode.

COOL/HEAT/FAN MODE OPERATION

1. Press "MODE" button, select "COOL" , "HEAT" or "FAN ONLY" mode.
2. Press temperature adjust button to select setting temp..
3. Press "FAN SPEED" button to select high/mid/low/auto.
4. Press "ON/OFF" button, indoor unit operation lamp on, it works in selected mode. Press "ON/OFF" button again, it stops to work.

Remark: When in fan mode, no temperature can be set.

DRY OPERATION

1. Press " MODE " button, select " DRY " mode.
2. Press temperature adjust button to select setting temp.
3. Press " ON/OFF " button, indoor unit operation lamp on, it works in dry mode. Press ON/OFF button again, it stops to work.
4. In dry mode, economy operation and fan speed are ineffective.

TIMER SETTING

Timer on only:

1. Press " TIME ON " button, it display "SET" on LCD, and display " H " and "ON" , it is waiting for timer on setting.
2. Press " timer " on button repeatedly to adjust time setting.
3. If press this button and hold on, the time will increase at 0.5h, after 10h, it increase at 1h.
4. After setting 0.5 second, the wire controller send timer on information, it is finished.

Timer off only:

1. Press "TIME OFF " button, it display "SET" on LCD, and display " H " and ON, it is waiting for timer on setting.
2. Press "TIME OFF" button repeatedly to adjust time setting.
3. If press this button and hold on , the time will increase at 0.5h, after 10h, it increase at 1h.
4. After setting 0.5 second, the wire controller send timer off information, it is finished.

TIMER ON AND TIMER OFF BOTH

1. Set timer on time as the corresponding step1 and 2.
2. Set timer off time as the corresponding step1 and 2.
3. Timer off time must be longer than timer on time.
4. 0.5 second after setting, the wire controller send information. the setting is finished.

CHANGE TIMER

If there is a need of changing timer time, press corresponding button to revise it. If cancel timer, change timer time to 0.0.



NOTE

The timer time is relative time,that is delay after setting time(i, e: setting time is 8:05 A,M). So when timer is set, the standard time can not be adjusted.

8. TECHNICAL INDICATION AND REQUIREMENT

- 1.EMI and EMC comply to CE,
- 2.Electrical safety comply to:
GB4706.32-2004,GB/T7725-2004

Version: QS01X-002BW

202000100350

Brivis Programmable Controller OWNER'S MANUAL



Brivis Ducted Inverter Programmable Controller

Brivis Part No: B026001

Brivis Climate Systems Pty Ltd
Tel: 1300 BRIVIS
brivis.com.au

Thank you very much for purchasing our product.
Before using your unit, please read this manual carefully and keep it for future reference.

- This manual provides a detailed description of the precautions that should be brought to your attention during operation.
- In order to ensure correct service of the wired controller please read this manual carefully before using the unit.
- For future reference, keep this manual in a safe place after reading it.



CONTENTS

1. SAFETY PRECAUTION.....	1
2. SUMMARISE.....	2
3. FUNCTION SUMMARY.....	2
4. NAME AND FUNCTION OF INDICATORS ON THE CONTROLLER.....	3
5. INSTALLATION METHOD.....	4
6. NAME AND OPERATION OF THE CONTROLLER BUTTONS.....	5
7. METHOD OF OPERATION.....	7
SET TIME.....	7
SET DATE	7
SET MODE.....	8
SET FAN SPEED.....	8
QUERY PLAN / PROGRAM.....	9
SET PLAN / PROGRAM.....	9
8. TECHNICAL INDICATION AND REQUIREMENT.....	11
9. TABLE OF ALARM STATES / FAULTS.....	11
10. TABLE OF PROTECTION STATES / FAULTS.. ..	12

1. SAFETY PRECAUTIONS

The following contents are stated on the product and the operation manual, including usage, precautions against personal harm and property loss, and the methods of using the product correctly and safely. After fully understanding the following contents (identifiers and icons), read the text and observe the following rules.



■ Identifier description

Identifier	Meaning
 Warning	Means improper handling may lead to personal death or severe injury.
 Caution	Means improper handling may lead to personal injury or property loss.

[Note]: 1. "Harm" means possible injury, burn and/or electric shock

2. "Property loss" means loss of properties and materials.

■ Icon description

Icon	Meaning
	It indicates forbidden. The forbidden subject-matter is indicated by the icon or by images or characters beside.
	Indicates compulsory implementation. The compulsory subject-matter is indicated by the icon or by images or characters aside.

Warning

 Warning	Delegate installation	Only suitably authorised and trained professionals should install the unit. Improper installation performed by the user without permission may cause fire, electric shock, personal injury or water leak.
---	-----------------------	--

 Usage Warning	Forbid	Do not spray flammable aerosols onto the wired controller directly. Otherwise, damage or fire may occur.
	Forbid	Do not operate with wet hands or use water around the wired controller. Otherwise, electric shock may occur.

2. SUMMARY

Usage condition:

1. Power supply: 5V DC.
2. Operational temperature limits:
-15°C (-5°F) ~ +43°C (+109°F).
3. Operational humidity limit: 40%-90% RH.

3. FUNCTION SUMMARY

Main function:

1. Connected to indoor unit by +5V, E, E, Y, X terminals;
2. Button setting action mode.
3. LCD display.
4. Up to a total of eight (8) programs for each day of the week.

4. DISPLAY NAME AND FUNCTION ON PROGRAMMABLE CONTROLLER

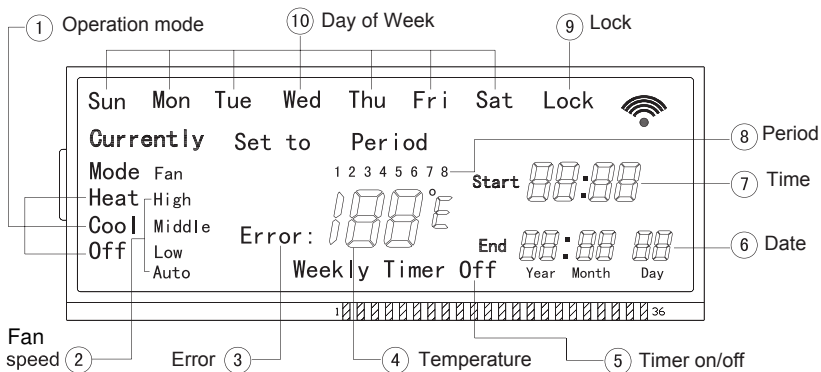

①Operational mode indication:

By pressing "MODE" then either "ADD" or "REDUCE", the mode of operation can be changed/cycled:

Cool => Heat => Off.

②Fan speed indication :There are four fan modes : low, middle, high and auto. On some models, no middle fan speed is available, in this case, the middle fan speed is seen as high speed.

③Fault indication.

④Temperature indication.

⑤Programmable Controller switch indication.

⑥Date indication.

⑦Time indication.

⑧Period indication.

⑨Lock indication.

⑩Day of Week indication.

WIRING DIAGRAM FOR BRIVIS DUCTED INVERTER WITH PROGRAMMABLE WIRED CONTROLLER

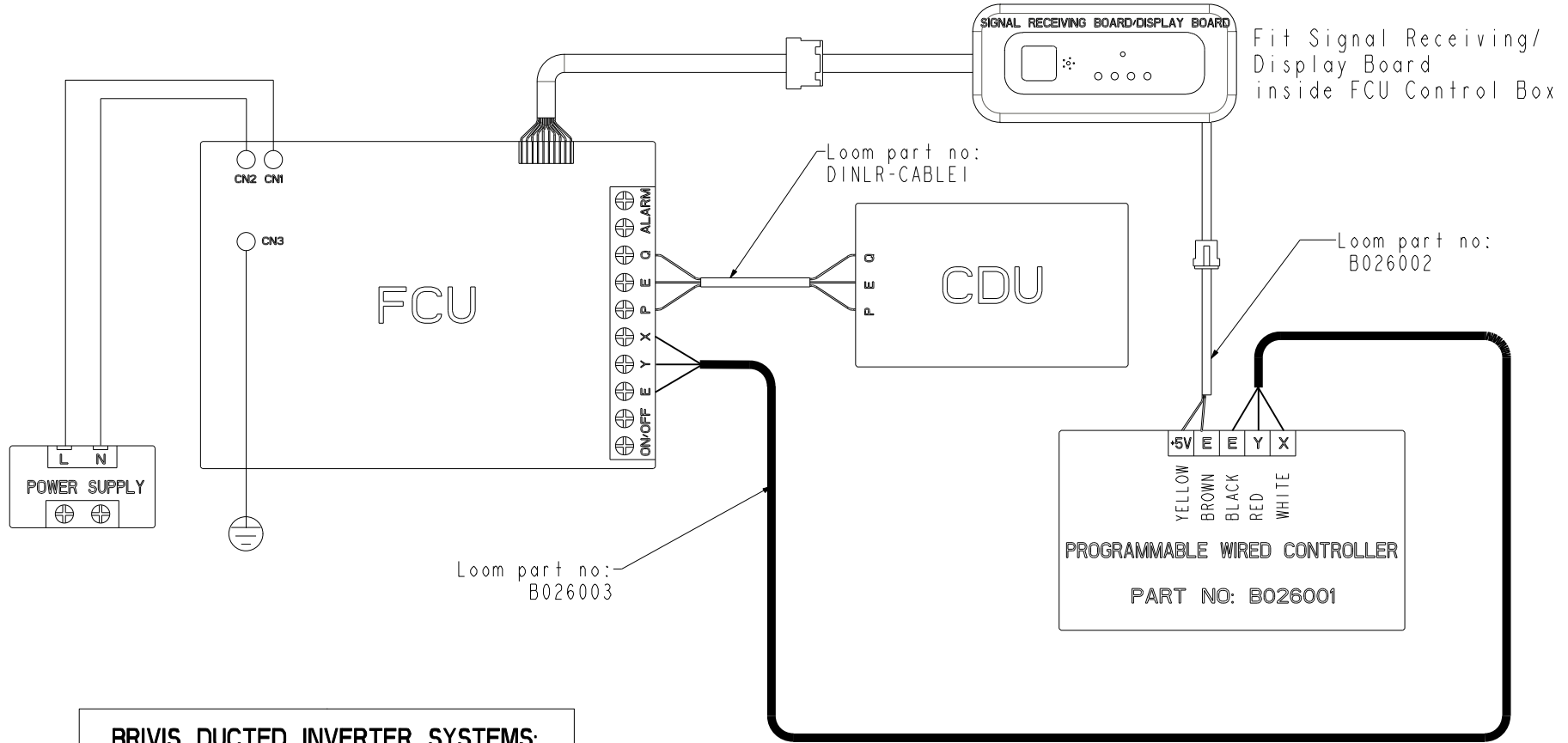

BRIVIS DUCTED INVERTER SYSTEMS:	
FCU	CDU
DINLR07Z7	DONSR07Z7
DINLR09Z7	DONSR07Z7
DINLR11Z7	DONSR11Z7
DINLR14Z7	DONSR14Z7
DINLR16Z7	DONSR16Z7

6. BUTTON NAME AND OPERATION OF THE PROGRAMMABLE CONTROLLER

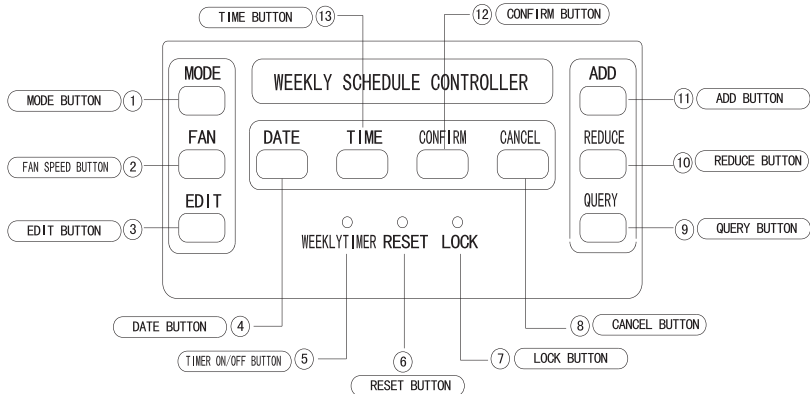

① Mode button:

By pressing "MODE" then either "ADD" or "REDUCE", the mode of operation can be changed/cycled:

Cool => Heat => Off.

To confirm this selection, press "CONFIRM".

② Fan speed button: press this button and "ADD" or "REDUCE" to select High, Middle, Low or Auto fan speed. To confirm this selection, press "CONFIRM".

③ Edit button: By pressing this button, you can setup Days of the Week, Date and Period.

④Date button: In the interim or normal display mode, press the button, and then enter the date, the sequence is year--month--day of the week. Set the date, and press the Confirm button after each entry. Ensure the correct setting of the date, (1 - 31). Pressing "CANCEL" will return you to the previous parameter changes.

⑤Timer on/off button: Pressing this button, will turn off the programmable function.

⑥Reset button: Pressing this button, will light all of the LCD segments for 2 seconds to signal a reset. After resetting, the LCD will turn off for 1 second. After this, the system will return to its normal display state and you can carry out the initial setup.

⑦Lock button: Press this button to lock and/or unlock the controller. Resetting power to the unit or restarting the unit after a power failure will not unlock the controller.

⑧Cancel button: Used to exit without saving a change/setting, or to cancel the lock.

⑨Query button: Press "QUERY" to select temperature values, press "CANCEL" to go back. Press "CONFIRM" to set time parameters, press "ADD " or "REDUCE" to select days from "Sunday" to "Saturday", press "CONFIRM" to save. Next select "1"~"8" for the time section, beginning from the first time section. Set mode, fan speed start and stop times, until all 8 time selections are completed. Press "CONFIRM" to save, then press "CANCEL" to finish.

⑩Reduce button: Used to reduce settings or to move left or up to other settings.

⑪Add button: Similar to reduce used to increase settings, or moving right or down to other settings.

⑫Confirm button: Used to confirm a selection.

⑬Time button: Press this button, and press "ADD" or "REDUCE" to adjust the hours value, press "CONFIRM" to then

adjust the minutes. Press "ADD" or "REDUCE" to adjust the minutes, press "CONFIRM" to save and go back.

7. CONTROLLER SETUP

SET TIME

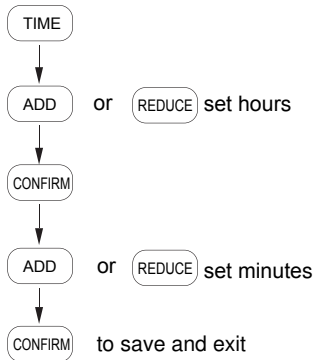

NOTE

Press the "CANCEL" button to go back to the previous step, or the normal display screen.

SET DATE

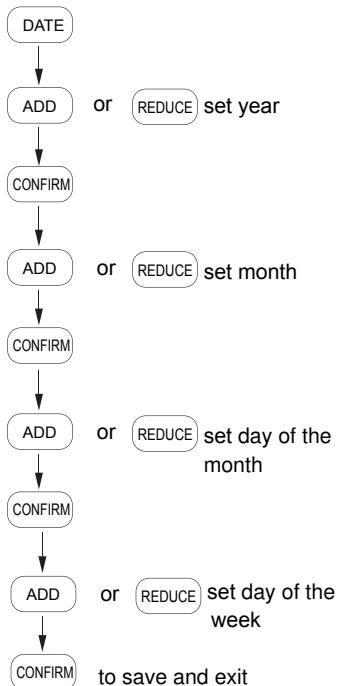



NOTE

Press the "CANCEL" button to go back to the previous step, or the normal display screen.

SET MODE

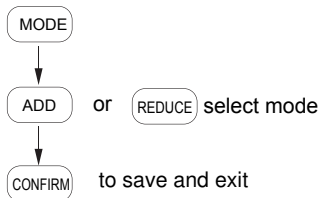

NOTE

Press the "CANCEL" button to go back to the previous step, or the normal display screen

SET FAN SPEED *Unit must be on to set fan speed

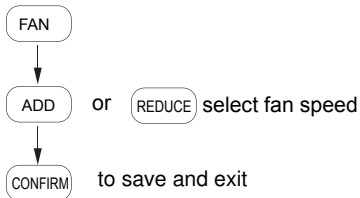

NOTE

Press the "CANCEL" button to go back to the previous step, or the normal display screen

QUERY PLAN

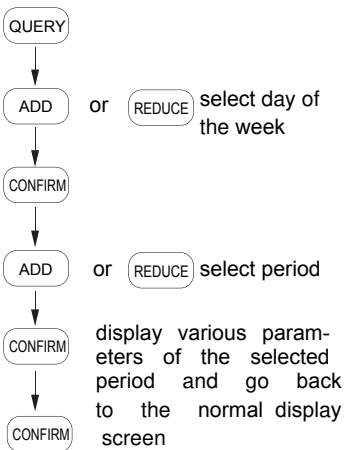

NOTE

Press the "CANCEL" button to go back to the previous step, or the normal display screen.

SET PLAN

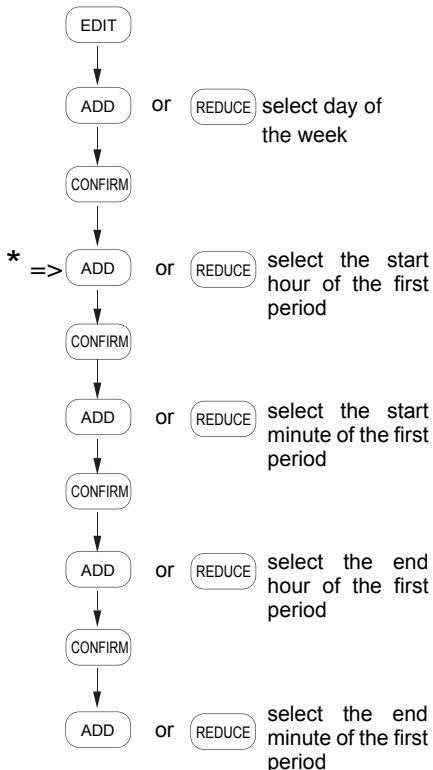

continued on next page

from previous page

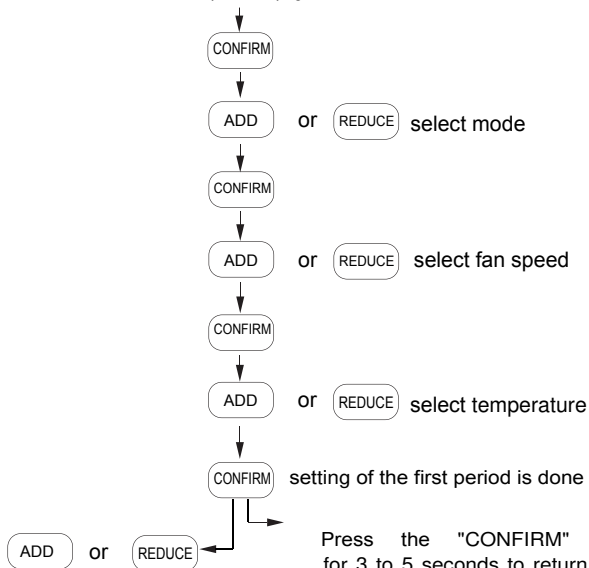

Press the "CONFIRM" button for 3 to 5 seconds to return to the 'select day of the week' step directly.

Set the parameters of the next period from "*"=>" in the 'select start hour' section above, until all of the eight periods of the same day are complete.



NOTE

Press the "CANCEL" button to go back to the previous step, or the normal display screen

If selecting "AUTO" in the fan mode in some time periods, the 'auto' fan fan speed will not be displayed. However, the fan will operate in "AUTO" mode but the controller will display "CURRENTLY".

8. TECHNICAL INDICATION AND REQUIREMENT

EMI and EMC comply to CE

9. TABLE OF ALARM STATES / FAULTS

Alarm states	Description
EF	Other defined faults
EE	Water level detection fault
ED	Outdoor unit protection
EA	Compressor overcurrent (4 times)
E8	Supply air fan speed out of scale
E7	EEPROM error
E6	Zero-crossing detection error
E8	Air discharge temperature sensor fault T3, T4 or digital compressor
E5	T2B Sensor fault
E4	T2A Sensor fault
E2	T1 Sensor fault
E1	Communication fault
E0	Phase sequence error or default
F1	Programmable controller sensor fault

10. TABLE OF PROTECTION STATES / FAULTS

Protection states	Description
PF	Other protection
P8	Compressor overcurrent
P7	Power supply over-under voltage protection
P6	Low pressure protection
P5	High pressure protection
P4	Supply air temperature protection
P3	Compressor temperature protection
P2	Condensing Unit high temperature protection
P1	Anti-cool supply air or defrost protection
P0	Evaporator temperature protection

End Document

Brivis Climate Systems

www.brivis.com.au

Tel: 1300 BRIVIS

Tel: 1300 274847

September 2012